



LS-FLIN 50
SYSTEM

LS-FLIN 50 SYSTEM

LIGHTSAVE LED

MOUNTING

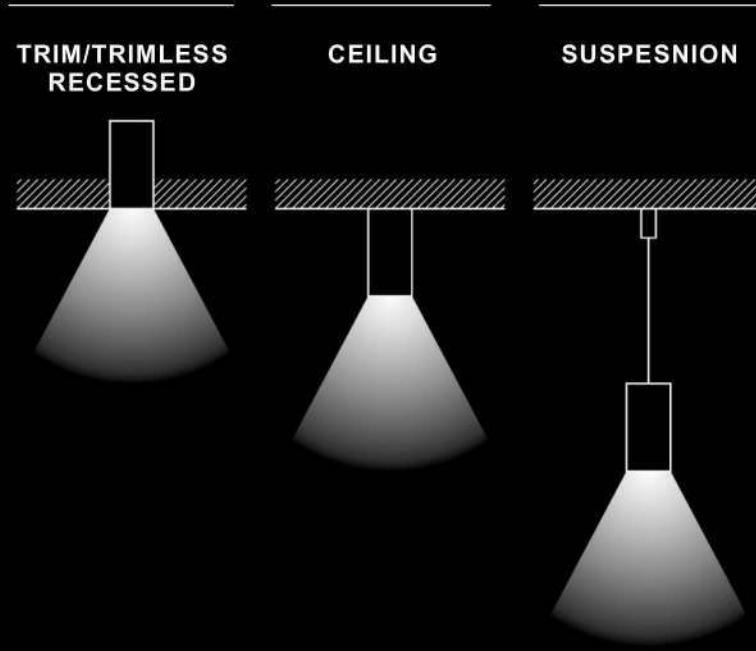

SHARPS

CURVE CORNER

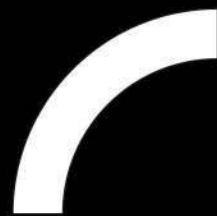

"L" CORNER

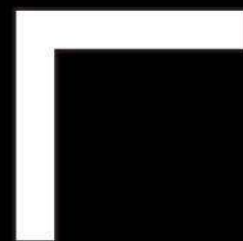

"T" CORNER



"+" CORNER

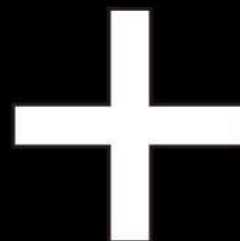

CONTROL

NON-DIM
3000K/4000K

DALI DIM
3000K/4000K

SURFACE COLOR

SILVER GREY



WHITE



BLACK



Description

A unique modular profile light system with a width of 54 mm; large range of versions for specific project requirements; either for surface, suspended or recessed mounted variants for trimless installation in plasterboard ceilings; designed for continuous lighting systems, fast connection kits for flexible system design; with an integrated power rail profile for supply voltage feed; lighting modules as well as spotlights and suspended modules; available at 3000 K / 4000K temperature colours; either non dimmable or DALI dimmable variants.

Features

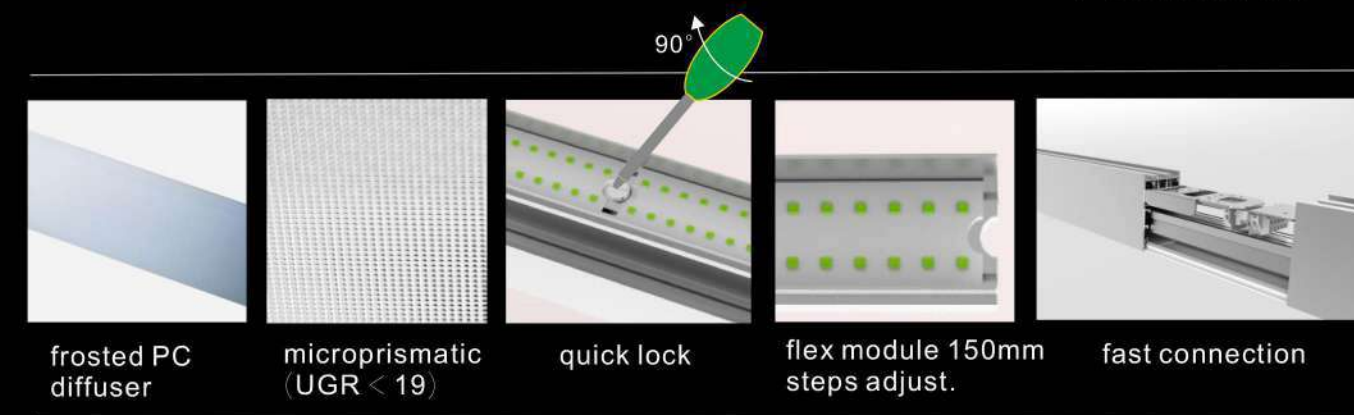

LIGHTSAVE LED

LS-FLIN 50 SYSTEM

WAGO
FAST CONNECTOR

FAST, EASY CONNECTIVITY

LS-FLIN50 SYSTEM adopts an exquisite professional design. The installation connectors only need to be plugged together; it is wiring free. Installation simply needs 2 external screws to complete the connection. Moreover, the connection kits are sturdy which prevents misalignment, and safeguards against lighting leakage

Sturdy section connectors provide rigid connections, avoiding deformity

Well designed and thoughtful for ease of assembly

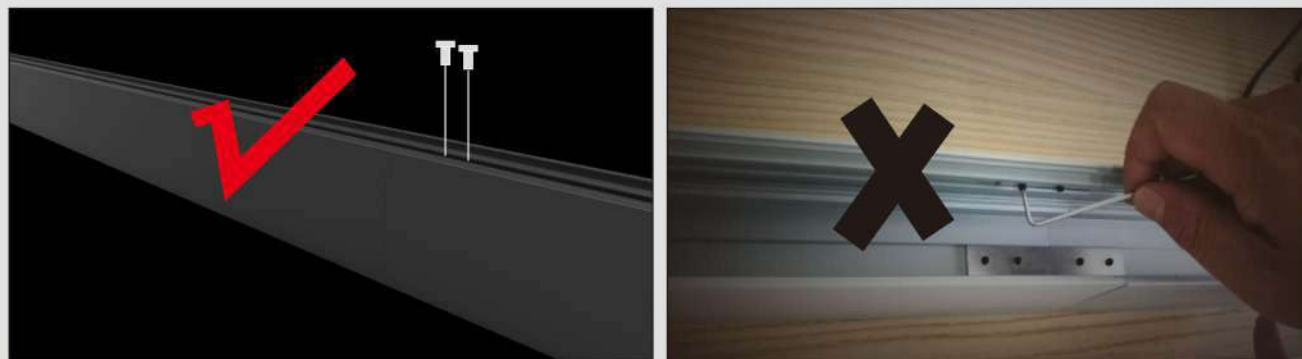



A case scenario with LS-FLIN50

Let us imagine you have installed 100pcs of linear lights.
For some unforeseen reason one of them is not working after years.

How do you go about analyzing and/or taking repair action by using the FLIN50 System?

SIMPLE and unlike most systems where you have to dismantle all the lamps installed to be able to repair it, now with LS-FLIN50 you just remove the section that needs attention, solve the issue and put it back.

That is it! We are thinking of you by using thoughtful, innovative design.

Easy assembly and maintenance

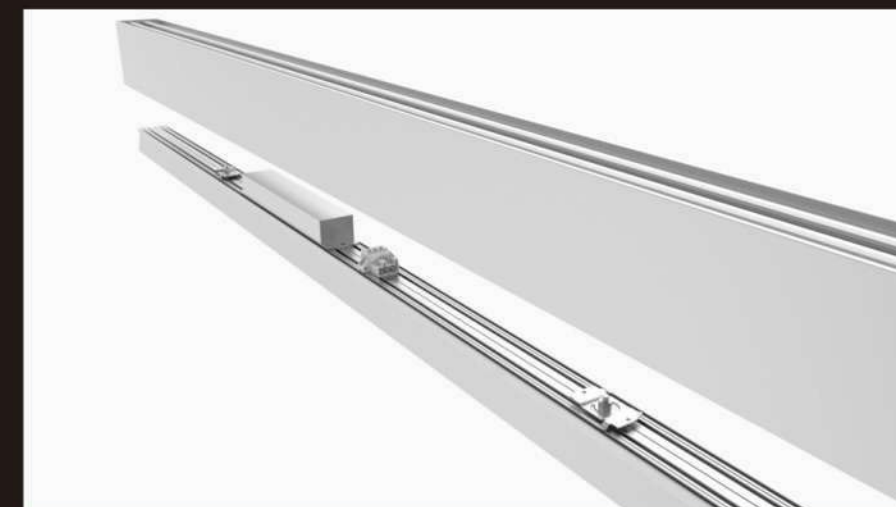
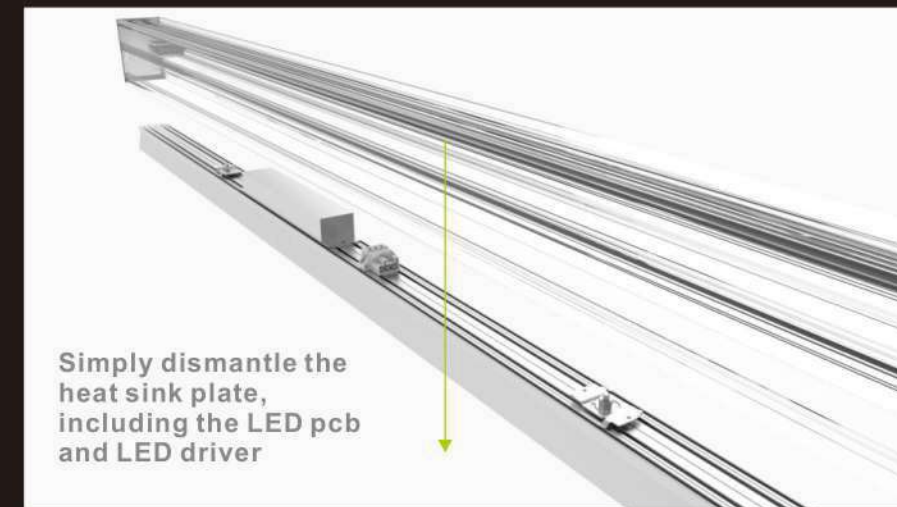
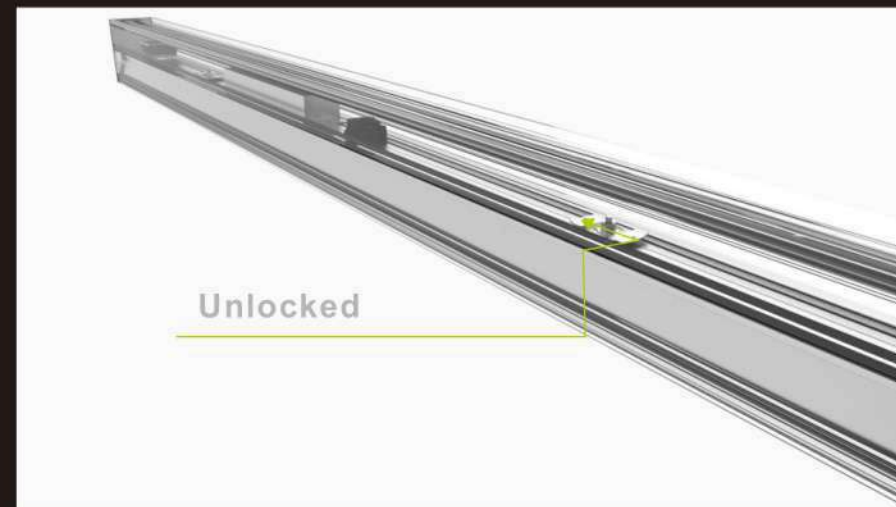
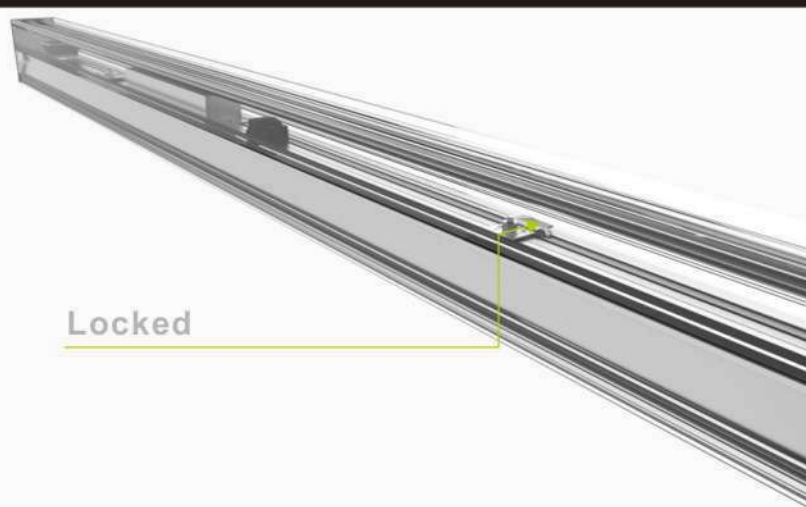

LS-FLIN 50 SYSTEM

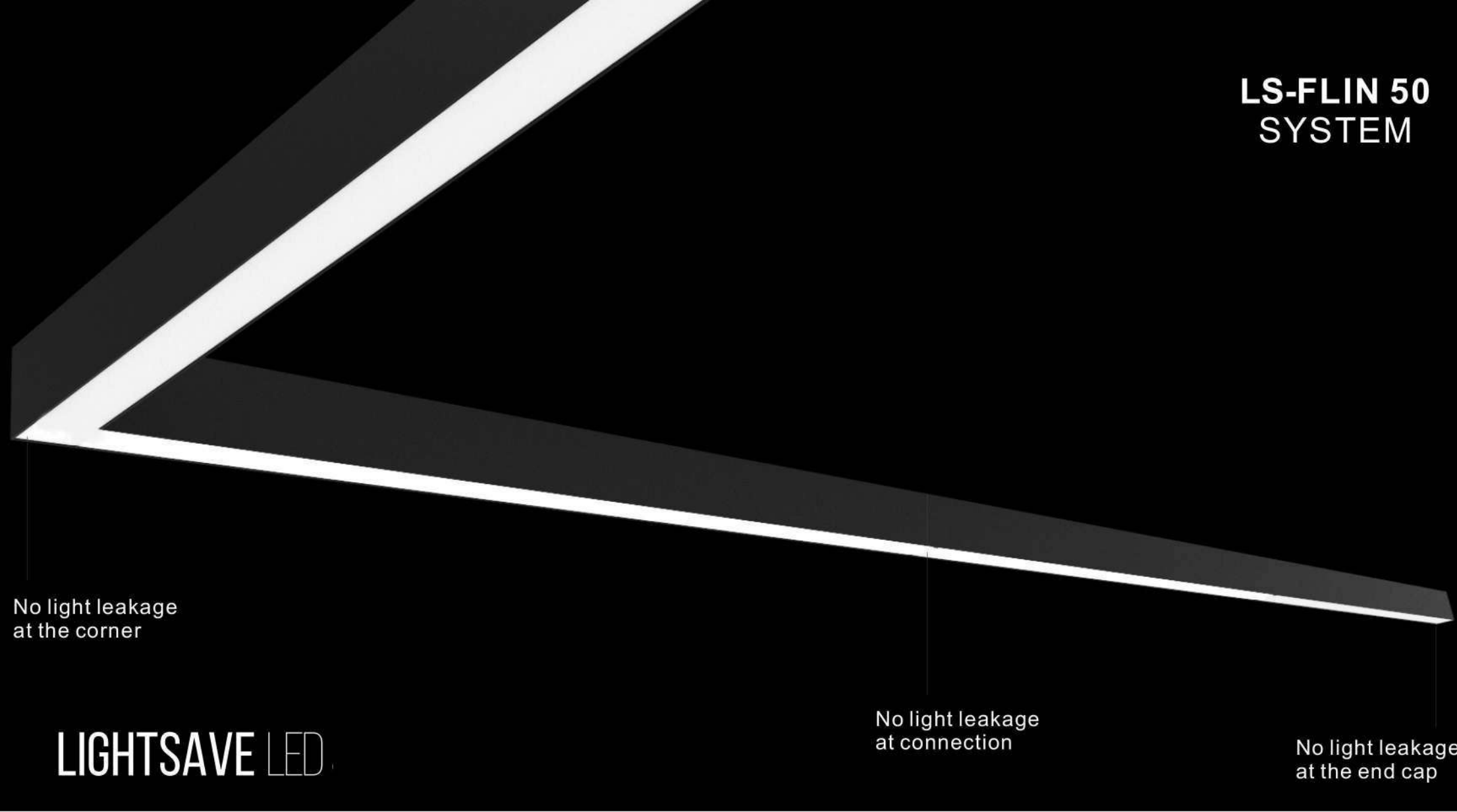

No light leakage at the corner

No light leakage at connection

No light leakage at the end cap

LIGHTSAVE LED

Total light leakage prevention

Due to the sturdy, strong connection kits, the FLIN50 system maximizes the prevention of light leakage. It is totally free from unwanted gaps. From end to end, all the covers are clip on and completely screw free

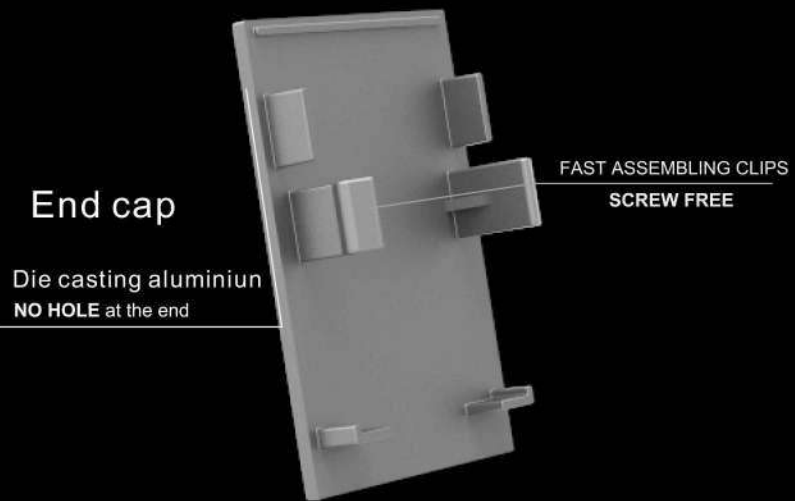

Modular Design

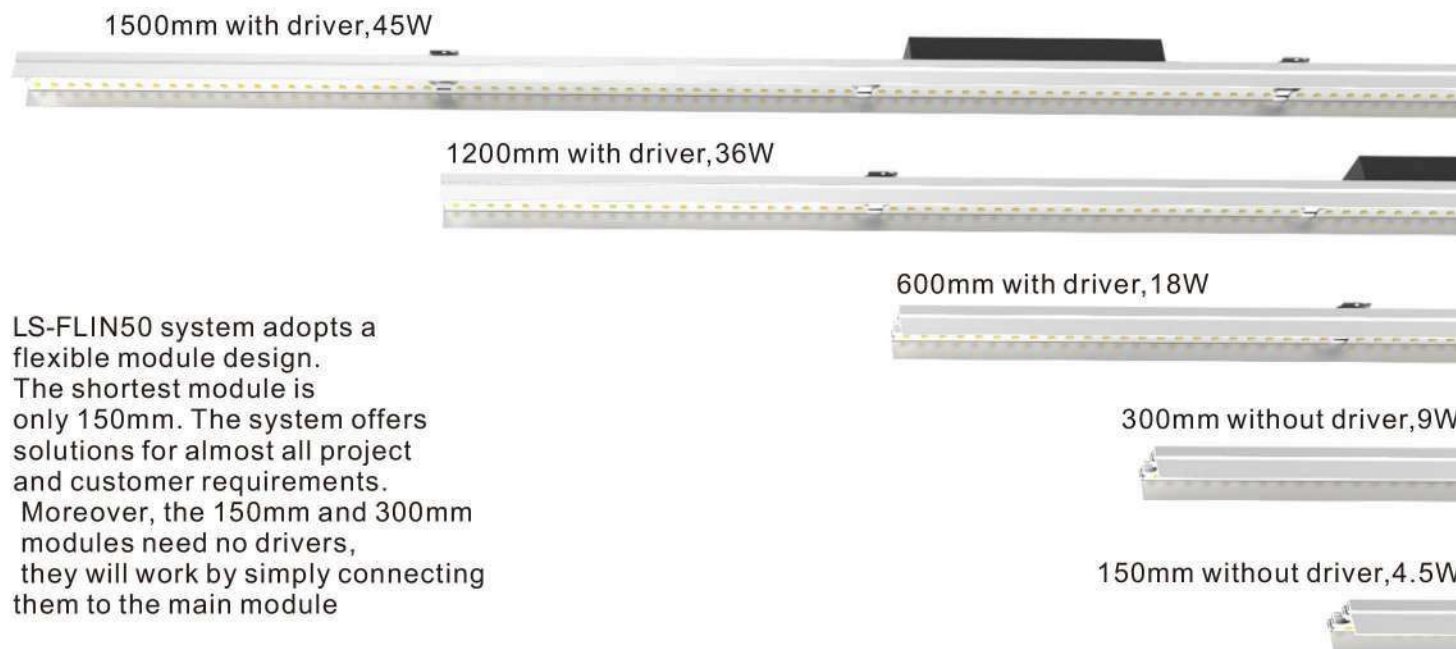

LS-FLIN50 system adopts a flexible module design. The shortest module is only 150mm. The system offers solutions for almost all project and customer requirements. Moreover, the 150mm and 300mm modules need no drivers, they will work by simply connecting them to the main module

Module extension

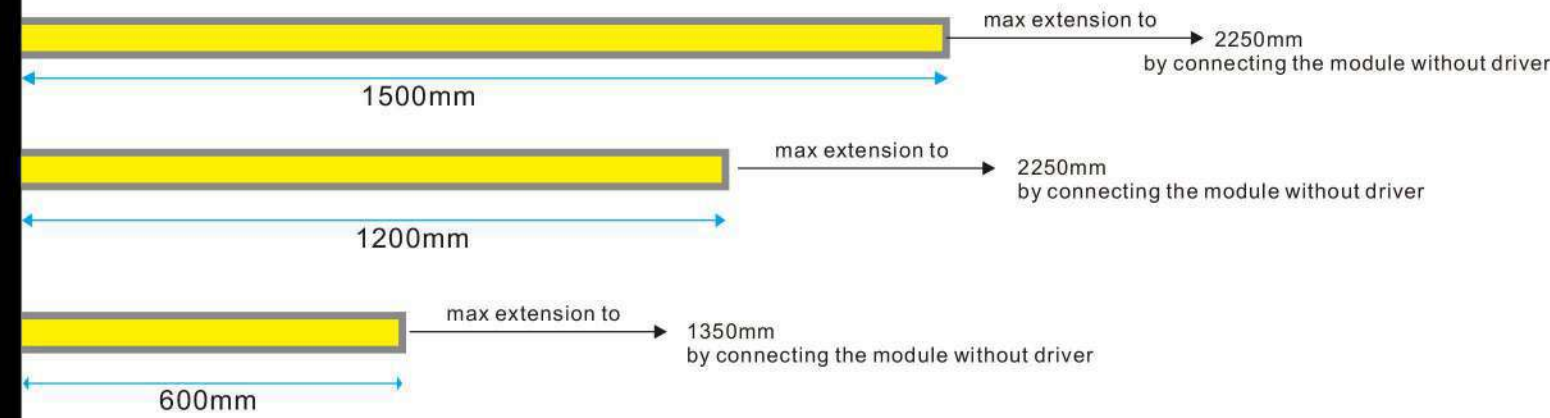

SPECIFICATION

ITEM NO.	LENGTH	SYSTEM POWER	CCT	SYSTEM LUMEN	LED	DRIVER
FLIN50-6-WW	600mm	18W	3000K	1890lm	OSRAM	OSRAM
FLIN50-6-PW	600mm	18W	4000K	1980lm	OSRAM	OSRAM
FLIN50-12-WW	1200mm	36W	3000K	3780lm	OSRAM	OSRAM
FLIN50-12-PW	1200mm	36W	4000K	3960lm	OSRAM	OSRAM
FLIN50-15-WW	1500mm	45W	3000K	4725lm	OSRAM	OSRAM
FLIN50-15-PW	1500mm	45W	4000K	4950lm	OSRAM	OSRAM

TRIM RECESSED

FLIN50T-6-WW	600mm	18W	3000K	1890lm	OSRAM	OSRAM
FLIN50T-6-PW	600mm	18W	4000K	1980lm	OSRAM	OSRAM
FLIN50T-12-WW	1200mm	36W	3000K	3780lm	OSRAM	OSRAM
FLIN50T-12-PW	1200mm	36W	4000K	3960lm	OSRAM	OSRAM
FLIN50T-15-WW	1500mm	45W	3000K	4725lm	OSRAM	OSRAM
FLIN50T-15-PW	1500mm	45W	4000K	4950lm	OSRAM	OSRAM



5 years warranty

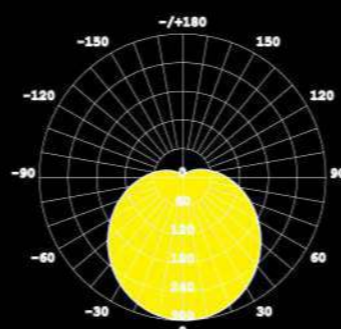
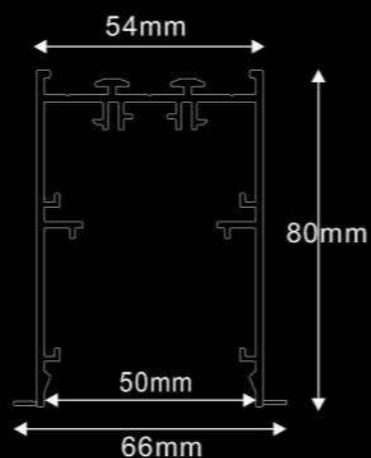
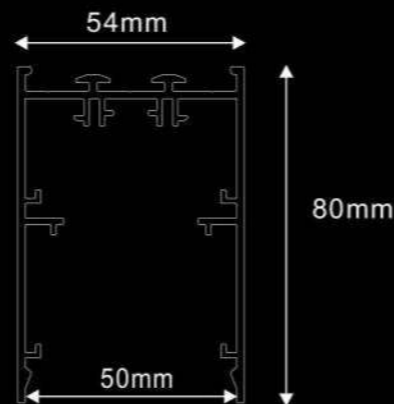

ITEM NO.	LENGTH	SYSTEM POWER	CCT	SYSTEM LUMEN	LED	DRIVER
"L" CORNER						
FLIN50-L-WW	300x300mm	18W	3000K	1890lm	OSRAM	OSRAM
FLIN50-L-PW	300x300mm	18W	4000K	1980lm	OSRAM	OSRAM
"T" CORNER						
FLIN50-T-WW	600x300mm	27W	3000K	2835lm	OSRAM	OSRAM
FLIN50-T-PW	600x300mm	27W	4000K	2970lm	OSRAM	OSRAM
"+" CORNER						
FLIN50-P-WW	600x600mm	36W	3000K	3780lm	OSRAM	OSRAM
FLIN50-P-PW	600x600mm	36W	4000K	3960lm	OSRAM	OSRAM

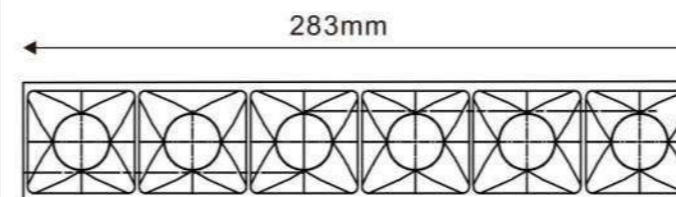
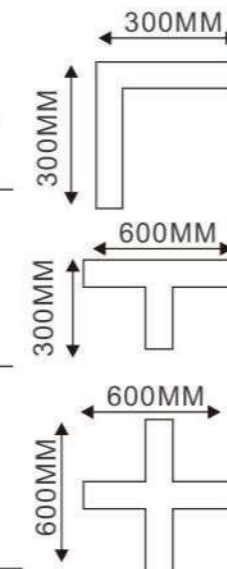

ITEM NO.	LENGTH	SYSTEM POWER	CCT	SYSTEM LUMEN	LED	DRIVER
SPOT MODULE						
FLIN50-SM-WW	283mm	12W	3000K	1080lm	OSRAM	OSRAM
FLIN50-SM-PW	283mm	12W	4000K	1140lm	OSRAM	OSRAM

90° CURVE CORNER

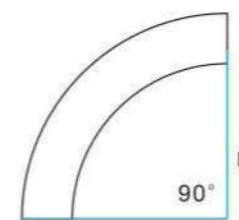

45° CURVE CORNER

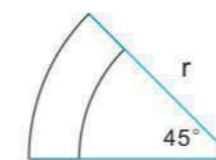

we provide customized service for curve corner with the diameter to suit the different projects' requirements.



How to order ?

For distributors, stock makers

Due to the modular designs and the fast assembly design features, LS-FLIN50 system will ease purchase and stock requirements.

You can order 2.5 meter maxi lengths of the profile, and order different length modules, cut and assemble them according to your customer's requirements !

Assembly tips?

We will send you a very detailed assembly manual upon request. You will discover just how convenient, straight forward well thought out our designs are!

For project customers

If you already have the detailed project demand, you would like us to assess with what you will need, just let us know how many lines you need to link, and how many meters per line?

Why ?

Due to the modular design, and considering that the shortest module is just under 150mm, the system enables us to use variable lengths in the middle of an installation. We will take the project into consideration and assist you with a usable solution and at the most competitive cost.



As an example, if your project consists of just one line, and for a length of 50meters, we would recommend the following:

One first section 1.35m, one end section 1.35m, plus 21 pcs of middle sections X 2.25m, instead of the solution 42PCS X 1.2m

Saving benefits?

1. save half your labour costs in connections
2. save on the cost of connection kits
3. save on the drivers
4. professional appearance due to fewer connections

Installation accessories

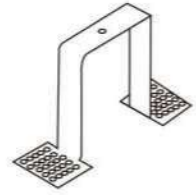

Trimless recessed

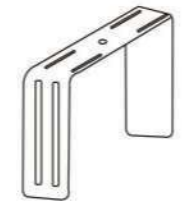

Trim recessed

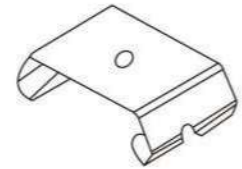

Ceiling/suspension Bracket



suspension wire

Application

